

CARSON

Carson Manufacturing Co., Inc.
5451 North Rural Street
Indianapolis, IN 46220
Phone: (888) 577-6877 Fax: (317) 254-2667
www.carsonsirens.com

TECHNICAL BULLETIN

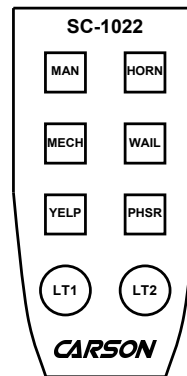
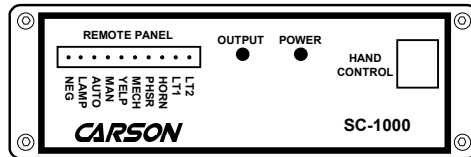
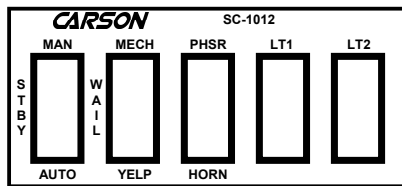
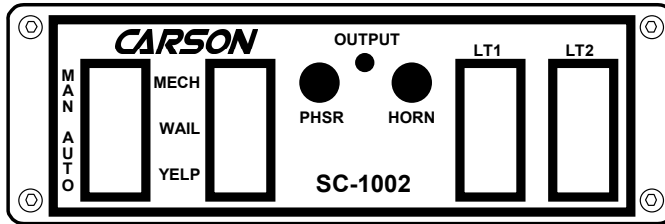

INSTALLATION AND OPERATING MANUAL

SC-1002 / 1012 / 1022-10 14V (Old Version) Different DIP Switch Options

Carson is a trademark of Carson Manufacturing Company, Inc.

WARNING



Sound Hazard - Sound level from siren speaker (>120dBA @ 10 feet) may cause hearing damage. Do not operate siren without adequate hearing protection for you and anyone in immediate vicinity. (Ref. OSHA 1910.95 for occupational noise exposure guidelines)

SC-1000 / 1012 / 1022-10 SPECIFICATIONS

AMPLIFIER INPUT POWER:	9-16 Volts DC, 8 Amps DC
SIREN MODE	
OUTPUT POWER:	105 Watts RMS (15 VDC input, 100W speaker)
SIREN	
FREQUENCY:	700Hz - 1500Hz Nominal
CYCLE RATES:	MECHANICAL - 5 cycles/min WAIL - 13 cycles/min YELP - 190 cycles/min PHASER - 15 cycles/sec TWO-TONE - 1 cycle/sec
OPERATING	
TEMPERATURE:	-15° F to +140° F
SIZE:	SC-10XX Amplifier 6" Wide X 2" High X 6" Deep SC-1012 Control Head 4-1/2" Wide X 2" High X 1-3/4" Deep SC-1022 Control Head 1-7/8" Wide X 4" High X 1" Deep
WEIGHT:	3.5 pounds
NIGHT VISIBILITY:	SC-1002 Backlit front control panel when power is on SC-1012 Light control switches illuminate when turned on SC-1022 Backlit front control panel when power is on
AMPLIFIER PROTECTION:	High Voltage – Siren output stops with input voltage above highest rating Stops high output power from blowing speaker Reverse Polarity – Fuse blows when power is wired backwards Shorted Output – Fuse blows if speaker shorts (a common problem)
LIGHT CONTROL INPUT POWER:	10-16 Volts DC, 20 Amps Max. not including siren input current
TWO LIGHT CONTROL OUTPUTS:	20 Amps Max. per circuit, 20Amps Max. Total
LIGHT CONTROL PROTECTION:	Shorted Output – Fuse blows

NOTICE

Due to continuous product improvements, we must reserve the right to change any specifications and information, contained in this manual at any time without notice.

Carson Manufacturing Co., Inc. makes no warranty of any kind with regard to this manual, including, but not limited to, the implied warranties of merchantability and fitness for a particular purpose.

Carson Manufacturing Co., Inc. shall not be liable for errors contained herein or for incidental or consequential damages in connection with the furnishing, performance, or use of this manual.

See www.carsonsirens.com for latest information.

INSTALLATION

Proper installation of the unit is essential for years of safe, reliable operation. Please read all instruction **before** installing the unit. Failure to follow these instructions can cause serious damage to the unit or vehicle and may void warranties.

SAFETY PRECAUTIONS

For the safety of the installer, vehicle operator, passengers and the community please observe the following safety precautions. **Failure to follow all safety precautions and instructions may result in property damage, injury or death.**

Qualifications - The installer must have a firm knowledge of basic electricity, vehicle electrical systems and emergency equipment.

WARNING



Sound Hazard - Sound level from siren speaker (>120dBA @ 10 feet) may cause hearing damage. Do not operate siren without adequate hearing protection for you and anyone in immediate vicinity. (Ref. OSHA 1910.95 for occupational noise exposure guidelines)

Mounting - Mount the unit for easy access by the vehicle operator. DO NOT mount in air bag deployment area. Assure clearances before drilling in vehicle.

Wiring - Use wiring capable of handling the current required. Make sure all connections are tight. Route wiring to prevent wear, overheating and interference with air bag deployment. Install and check all wiring before connection to vehicle battery.

Testing - Test all siren functions after installation to assure proper operation. Test vehicle operation to assure no damage to vehicle.

Keep These Instructions - Keep these instructions in the vehicle or other safe place for future reference. Advise the vehicle operator of the location.

MOUNTING (Main unit)

The mounting bracket supplied can be installed above or below the unit. Mounting bolts (standard 1/4-20) slide into channels on each side of the case. Lockwashers should be used between the case and bracket as well as between the bracket and nut. Choose a mounting location convenient to the operator and away from any air bag deployment areas. Inspect behind mounting area for clearance. Assure adequate ventilation to prevent overheating. Consider wire routing and access to connections. Install mounting bracket to vehicle using 1/4" hardware.

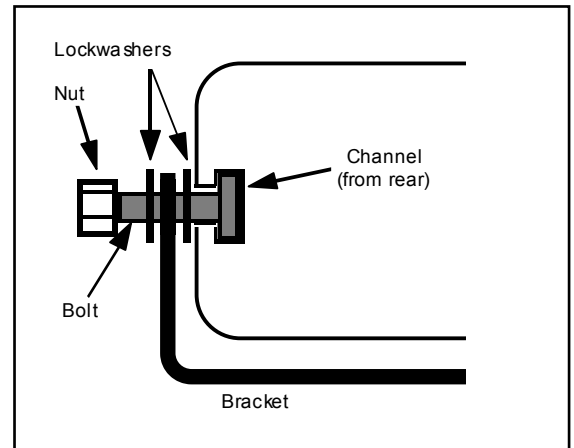

SC-1012 Remote Panel: The remote panel of the SC-1012 is typically mounted underneath the vehicle dashboard using mounting hardware. Mount the panel in a location away from the driver's or passenger's legs.

SC-1022 Hand Control: Choose a mounting location convenient to the operator and away from any air bag deployment areas. Consider cable routing to amplifier.

INSTALLER-SELECTABLE OPTIONS

An internal 8-position DIP switch on the circuit board may be changed to select various options.

Accessing Option Switches - the DIP switch is located just behind the front panel of the amplifier. Use a 7/64" allen wrench to remove the 4 corner screws then remove front panel.

Adjusting Option Switches - it is easiest to view the DIP switch with the unit turned upside down. With the unit upside down, the DIP Switch is located on the internal PCB assembly board toward the front center of the unit. Switch 'ON' position is toward the inside of the unit.

SW-1 (AUX_P) Auxiliary Input Polarity - The auxiliary input is normally activated with positive. Turn this switch OFF for negative activation.

SW-2 (INST_ON) Instant ON - The Enable input wiring is normally required to turn on the unit. Turn this switch ON to allow the front panel switches to instantly turn on the unit.
(SC-1002 and SC-1012 only)

SW-3 (T-T) Two-Tone - Turn this switch ON to replace Phaser with Two-Tone.

SW-4 (H_I) Horn Inhibit - Turn this switch ON to disable Horn tone. Horn will be replaced with Yelp.

Siren Tone Disable - All siren tones may be disabled (except Manual, Wail, and Yelp) by turning ON both switches SW-3 and SW-4. Mechanical will be replaced with Wail. Phaser and Horn will be replaced with Yelp.

SW-5 (HRC) Horn Ring Cyclor 2 (HRC2) - Turn this switch ON to enable this feature. Also connect the auxiliary input to the horn ring or other switch. While the siren is in standby, tap the horn ring to bring the unit out of standby into Mechanical tone. Repeatedly tapping the horn ring will cycle through Mechanical, Wail, Yelp, and Phaser tones. Tapping the horn ring twice quickly will stop the siren tones and return the unit to standby. Pressing and holding the horn ring will produce Horn tone until released. Then the siren will return to its previous siren tone or standby.

SW-4 (P_I) Phaser Inhibit - Turn this switch on to disable Phaser and Two-Tone.

SW-6 (SM) Short Manual - The Manual siren tone will normally fall and die out when released. Turn this switch ON to have Manual stop immediately.

SW-7 (MECH2) Mechanical Tone 2 - Turn this switch ON for a different mechanical tone sound. (less raspy)

SW-8 (FALL) Mechanical Fall - Turn this switch ON for a quicker mechanical tone fall time.

ELECTRICAL CONNECTIONS

Disconnect vehicle battery before making any electrical connections.

Electrical connections to the unit are made using a removable terminal block plug and screw terminals located on the amplifier. A label on the unit identifies each terminal function. Install the plug on the unit before wiring. If the unit needs service the plug can be easily removed without unwiring. The power supply of the unit must be capable of delivering peak currents up to 50 amps for adequate short circuit protection and reliable operation. The preferred source is directly at the vehicle battery. The amplifier is fused. Attach leads by stripping 3/8", inserting into plug and clamp by tightening screw. Make sure the screw is tight and the wire can't be pulled out.

Failure to adequately tighten the screw can result in improper operation or burning the connector and wire.

Wire Size and Termination - The diagram shows the minimum wire size used for each connection, along with recommended lead color. If the wire is longer than 10 ft. use the next larger wire size. Use only high quality crimp connectors for installation on the vehicle.

Enable Input Connection (ORG lead on wiring diagram next page) - **This is NOT the same as the main power connection.** The enable input is like a power switch for the unit. When there is positive power at this connection, the unit is powered up and ready to function. When power is removed, the unit is not powered up and will not drain current from the battery. Connect to a positive circuit controlled by the vehicle ignition switch, usually a terminal at the vehicle fuse panel. The required current is low (15mA typ.).

**For SC-1022:
The Enable Input must be connected.**

**For SC-1002 and SC-1012:
The Enable Input is optional.**

If it is not desired to wire the Enable Input, set the Instant ON DIP switch as described under INSTALLER SELECTABLE OPTIONS. The unit will instantly turn on when a switch on the face of the unit or the control panel is activated. This includes LT1 and LT2 switches. When all switches are deactivated, the unit will turn off. Without the enable input, the Manual siren tone will stop immediately. LT1 or LT2 switch may be used as power switch for the unit instead of Enable Input.

Auxiliary Input Connection (Optional) - A momentary input typically connected to the horn ring of the vehicle or other switch. See OPERATION section for auxiliary input functions.

NOTE: Permanent disconnection of the vehicle horn is NOT recommended.

The auxiliary input may be activated with positive or negative voltage. See Auxiliary Polarity under INSTALLER SELECTABLE OPTIONS section for proper activation polarity. Input current is 1 to 20 mA.

Aux Input for SC-1002 and SC-1012:

The unit must be turned on for the Auxiliary Input to function. This is accomplished with either the siren controls or Enable Input.

Instant ON option set and unit turned on with switch on face of unit or control panel. This includes LT1 or LT2.	Unit turned on with enable input	Auxiliary Input will Function
NO	NO	NO
YES	NO	YES
NO	YES	YES
YES	YES	YES

ELECTRICAL CONNECTIONS CONTINUED (ALL MODELS)

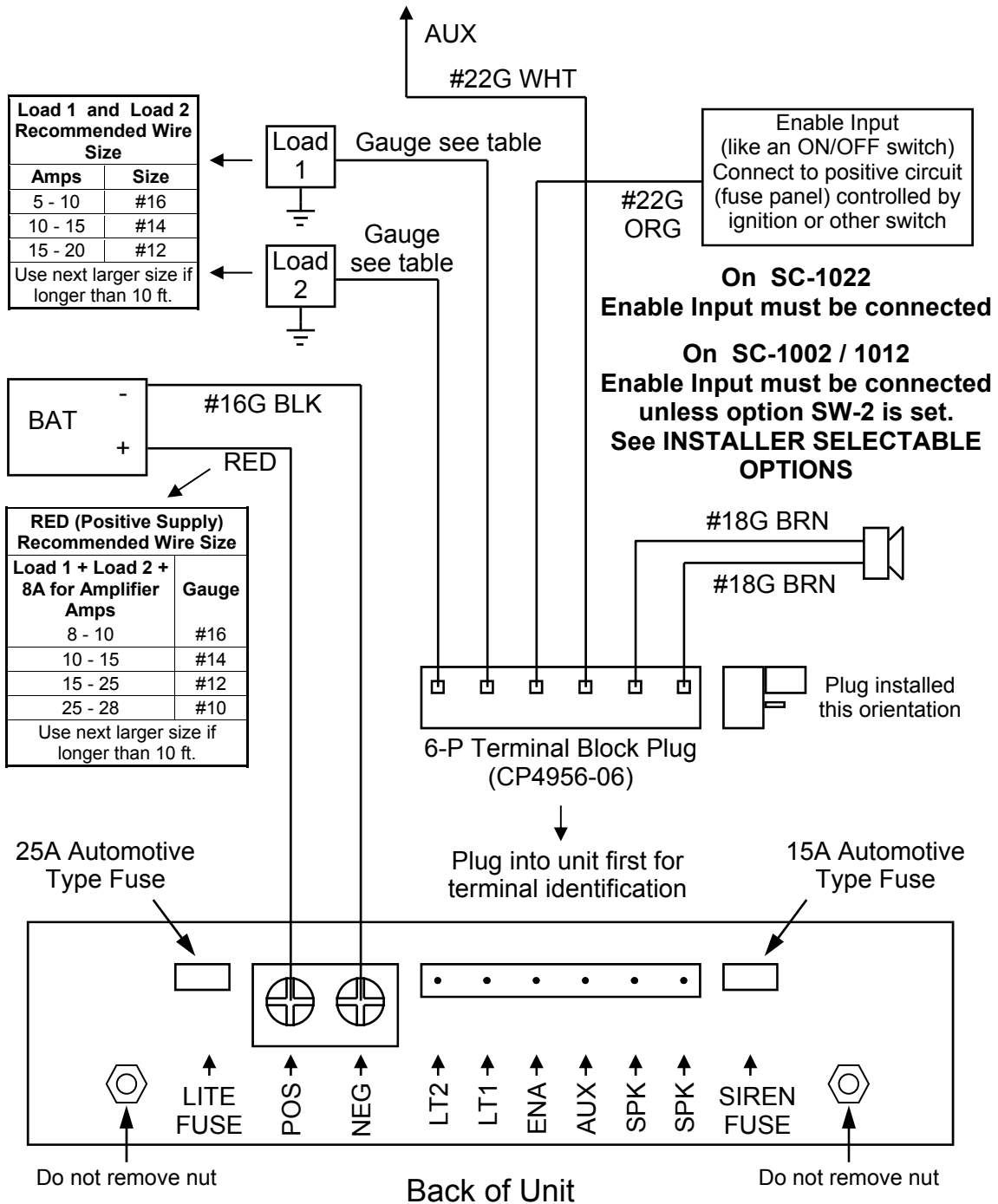
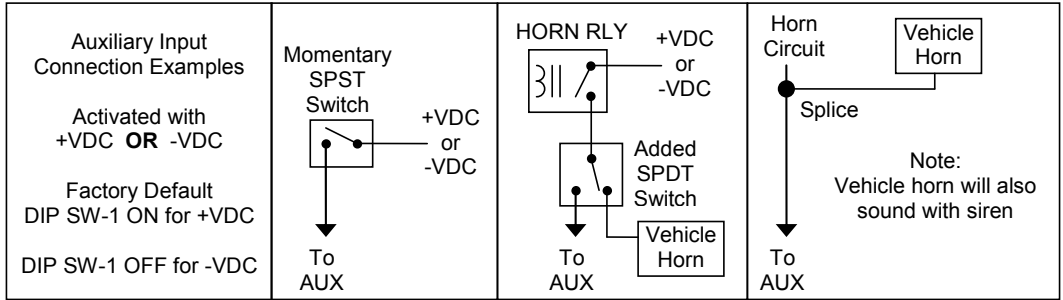

ELECTRICAL CONNECTIONS CONTINUED (SC-1012 only)

Front of Unit

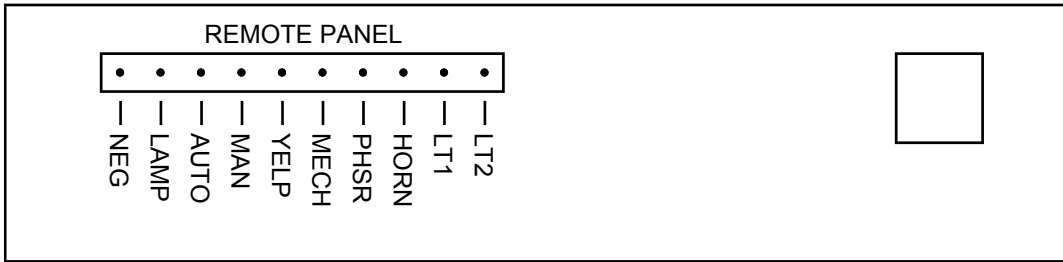

Plug into unit first for terminal identification

10-P Terminal Block Plug (CP4688-10)

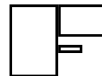
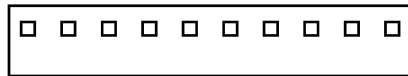

Plug installed this orientation

Remote Panel wired to terminal block plug
Suggest wires be #22G

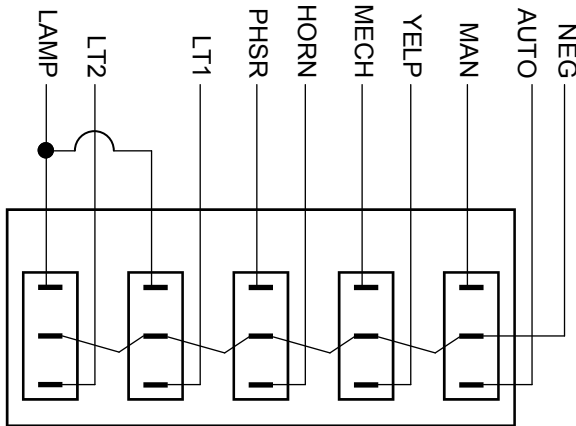

Note Top Orientation

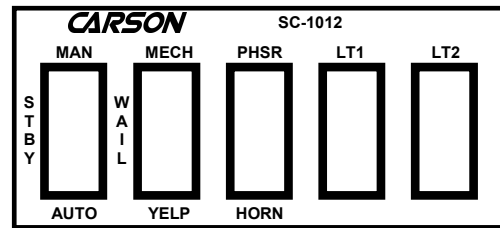

LT1 and LT2 Lighted Rocker Switches may control devices directly bypassing the unit.

LT1 and LT2
Lighted Rocker Switch
Circuit

LT1 and LT2 Lighted Rocker Switches are rated 15 Amps each.
Proper fusing should be used to protect the switch and circuit.

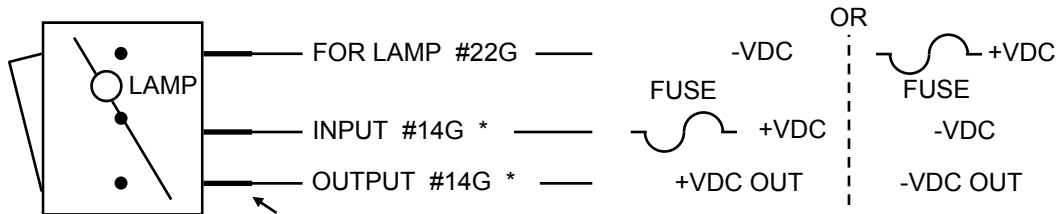

Observe Terminal Spacing for Orientation

* - See Load Wire Size chart on Page 8

ELECTRICAL CONNECTIONS CONTINUED (SC-1022 only)

Front of Unit

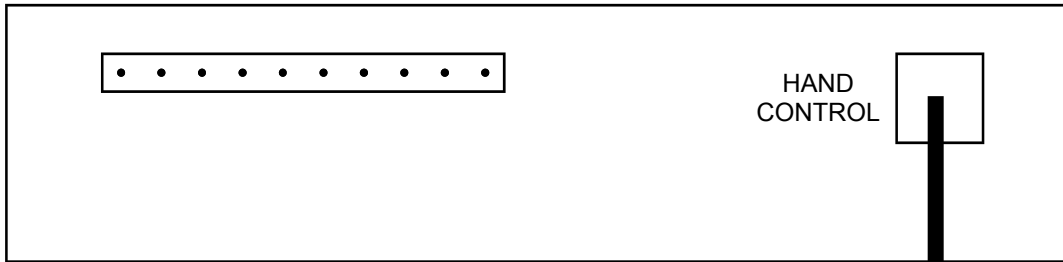

Plug hand control into unit

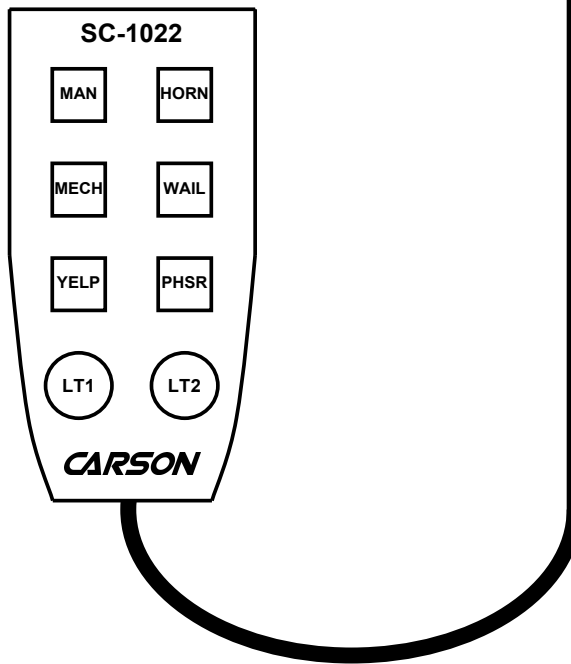

Note: Cable may be extended with ED1753 Hand Control Cable Extension Kit.
Do not extend with other cables which may cause unreliable operation or damage.

OPERATION

SC-1002 and SC-1012 Models

WARNING



Sound Hazard - Sound level from siren speaker (>120dBA @ 10 feet) may cause hearing damage. Do not operate siren without adequate hearing protection for you and anyone in immediate vicinity. (Ref. OSHA 1910.95 for occupational noise exposure guidelines)

POWER ON/OFF

Power to the unit is controlled by the vehicle ignition switch.

If the Instant ON feature is installed the unit may be turned on with siren or light controls.

See INSTALLATION and INSTALLER SELECTABLE OPTIONS section.

On the SC-1002 the backlight will turn on. On the SC-1012 remote amplifier the **POWER** light will turn on.

SIREN CONTROLS

MAN - STBY - AUTO SELECTOR SWITCH

A 3-position rocker selector switch controls the primary operating mode of the siren.

Manual - Provides manual control of Mechanical and Wail tone rise and fall or momentary Yelp depending on the position of Mech - Wail - Yelp switch.

Auto - Keeps siren tone running (automatic rise and fall). Tone depends on the position of Mech - Wail - Yelp switch.

Standby - A silent mode that may be overridden anytime.

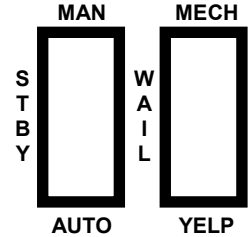

MECH - WAIL - YELP SELECTOR SWITCH

A 3-position rocker selector switch controls the primary siren tone.

Mech - A simulated mechanical siren tone. Tone may be changed or disabled.

See INSTALLER SELECTABLE OPTIONS section.

Wail - A slower changing tone used on highways.

Yelp - A rapidly changing tone used in congested areas.

SC-1002



PHASER BUTTON (SC-1002) or ROCKER (SC-1012)

A very rapid changing tone used at intersections and very highly congested areas. With selector switch in **Auto**, this tone override is toggled on and off by repeatedly pressing switch. With selector switch in **Standby**, this tone override is momentary as long as the switch is pressed. May be optionally replaced with **Two-Tone** or disabled. Two-Tone is two alternating frequencies like a European HI-LO. See INSTALLER SELECTABLE OPTIONS section.

SC-1012

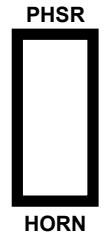

HORN BUTTON (SC-1002) or ROCKER (SC-1012)

Produces a simulated Air-Horn tone while pressed. Overrides all siren modes. Horn tone may be disabled. See INSTALLER SELECTABLE OPTIONS section.

AUXILIARY INPUT FUNCTIONS

The switch or horn ring attached is intended to be momentary. In most cases the ignition switch on the vehicle must be on for the Auxiliary Input to function. See INSTALLATION section.

With selector switch in **Standby**, activating auxiliary is the same function as activating **Manual**.

When the selector switch is in **Auto**, activating auxiliary will produce the Horn tone.

Horn Ring Cyclor 2 (HRC2) - this feature may also be added by turning on the HRC2 option. HRC2 is only available while the unit is in **Standby**. Tapping the attached horn ring or other switch, will bring the unit out of standby into Mechanical tone. Repeatedly tapping the horn ring will cycle through Mechanical, Wail, Yelp, and Phaser tones. Tapping the horn ring twice quickly will stop the siren tones and return the unit to standby. Pressing and holding the horn ring will produce Horn tone until released. Then the siren will return to its previous siren tone or standby.

Selector Position	Mech - Wail - Yelp Position	Phaser Switch	Horn Switch	Auxiliary Input (Horn Ring)
Standby	Silent	Mom. Phsr	Horn	M. Mech., M. Wail, or Yelp or HRC2
Manual	M. Mech., M. Wail, or Yelp	Phsr Toggle	Horn	Horn
Auto	Mechanical, Wail, or Yelp	Phsr Toggle	Horn	Horn

LIGHT CONTROLS

LT1 and LT2 LIGHTED ROCKER SWITCHES

When turned on the rocker switch will light up and activate the corresponding light output.

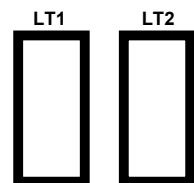

OPERATION

SC-1022 Model



WARNING **Sound Hazard** - Sound level from siren speaker (>120dBA @ 10 feet) may cause hearing damage. Do not operate siren without adequate hearing protection for you and anyone in immediate vicinity. (Ref. OSHA 1910.95 for occupational noise exposure guidelines)

POWER ON/OFF

The unit is normally turned on with ignition switch on the vehicle. See INSTALLATION section. The **POWER** light on remote amplifier will turn on. The hand control will also be backlit.

SIREN CONTROLS

MECH, WAIL, YELP, AND PHSR PUSHBUTTON SWITCHES

Four pushbutton switches control the primary operating mode of the siren. The primary operating modes are:

Standby - A silent mode that may be overridden at any time.

Mech - A simulated mechanical siren tone. Tone may be changed or disabled. See INSTALLER SELECTABLE OPTIONS section.

Wail - A slower changing tone used on highways.

Yelp - A rapidly changing tone used in congested areas.

Phaser - A very rapid changing tone used at intersections and very highly congested areas. May be optionally replaced with **Two-Tone** or disabled. Two-Tone is two alternating frequencies like a European HI-LO. See INSTALLER SELECTABLE OPTIONS section.

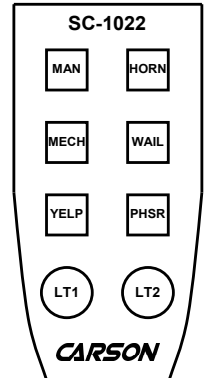

Momentarily press button to activate (lit red). Momentarily press button again to de-activate. Also while a particular mode is activated, switch to a different mode by pressing one of the other three buttons. The unit is in Standby when NONE of the four buttons are activated (NOT lit red). For example starting with all four buttons off, press the **Wail** button to turn on Wail. Now press the **Yelp** button to change to Yelp. Press the **Yelp** button again to turn off sound (return to Standby).

MAN PUSHBUTTON SWITCH

Provides manual control of siren tone depending on the primary operating mode selected.

While in Standby, the **Manual** button controls the Mechanical tone. Rising to peak while pressed then falling until die out when released.

While in Mech, Wail, Yelp, or Phaser mode, pressing the **Manual** button causes tone to rise and peak then resume when released.

HORN PUSHBUTTON SWITCH

Produces a simulated Air-Horn tone while pressed. Overrides all siren modes. Horn tone may be disabled. See INSTALLER SELECTABLE OPTIONS section.

AUXILIARY INPUT FUNCTIONS

The switch or horn ring attached is intended to be momentary. The ignition switch on the vehicle must be on for the Auxiliary Input to function. See INSTALLATION section.

While in Standby, activating auxiliary is the same function as activating **Manual**.

While in Mech, Wail, Yelp, or Phaser mode, activating auxiliary will produce Horn tone

Horn Ring Cyclor 2 (HRC2) - this feature may also be added. See description on Page 9.

Primary Mode and Tone	MAN Button	HORN Button	Auxiliary Input (Horn Ring)
Standby (Silent)	M. Mech	Horn	M. Mech. or HRC2
Mechanical	Man. Mech. Rise	Horn	Horn
Wail, Yelp, or Phaser	Man. Wail Rise	Horn	Horn

LIGHT CONTROLS

LT1 and LT2 PUSHBUTTON SWITCHES

Momentarily push button to activate (will light red) corresponding light output.

Momentarily push button again to de-activate corresponding light output.

SERVICE

This unit is designed to provide years of reliable service under even the worst conditions. Many times there may appear to be a problem with the unit when the true problem is in the speaker, controlled devices, or improper installation. The following chart shows typical symptoms and possible causes.

A blown siren fuse doesn't necessarily mean that the unit is bad. If a speaker or speaker lead is shorted this fuse will blow before the unit is damaged. Disconnect the speaker leads and replace the fuse. If the **OUTPUT** light comes on with siren power on and Wail mode selected the amplifier is OK. Check the speaker or leads for possible shorting.

PROBLEMS

Symptom	Possible Cause	Check
No power or siren output	No power to enable input (org wire) Bad speaker Connector(s) loose Rear panel fuse blown Loose connection at power source	Does backlighting or POWER light come on? Is the OUTPUT light on face coming on in Wail? Is an external fuse or circuit breaker used? Are the negative leads connected to a good ground?
No siren tones	Bad Speaker High Voltage Protection	Is the OUTPUT light on face coming on in Wail? Input voltage must be less than highest rated voltage.
Distorted siren sound	Speaker assembly loose Intermittent Aux Input connection Low vehicle voltage	Is the speaker bell or tip loose? Is the Aux Input used and wired properly? Input voltage must be greater than lowest rated voltage.
Intermittent siren tone	High Voltage Protection Connector loose Bad power connection Circuit breaker in supply connection	Is the vehicle voltage regulator working properly? Is the connector tight on the back of the unit? Is there a loose connection on a power lead? Is a circuit breaker used with at least a 50A rating?
Horn function stuck on or Manual stuck on	Horn or Manual switch stuck Aux Input improperly connected Aux Input Polarity Option set wrong	Does the horn or manual switch return when released? Is the Aux Input used and wired properly? Is the AUX_P option properly configured?
Wrong siren tone	Two-Tone option installed Tone disabled.	Is the T-T option selected? Check option switch settings.
Some siren tones not working	Tone disabled	Check option switch settings.
Light switches not working	Loose output connections Rear panel fuse blown	Do the Light Control switch indicators light? Is the corresponding fuse blown?

RETURN

If you have any questions concerning this or any other Carson product, please contact our **Technical Service Department** at (888) 577-6877. Many issues can be handled over the phone. We can also be reached via e-mail at service@carson-mfg.com

If a product must be returned for any reason, please contact our Technical Service Department to obtain a Returned Merchandise Authorization number (RMA#) before you ship the product to Carson. Please write the RMA# clearly on the package near the mailing label. Be sure to provide a return address, contact and phone number, along with a brief description of the problem.

SC-1002 PARTS

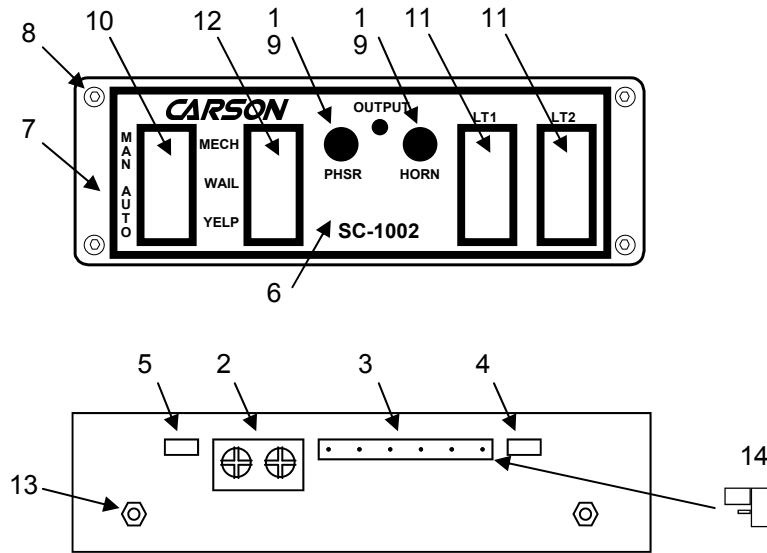

Item	Part #	Description
1	CP4837	Button, Switch Cap Red
2	CP4989-02	Connector, 2-P terminal block
3	CP4957-06	Connector, 6-P header
	CP4739	Cover, extruded (does not include Front Panel or slide out Chassis)
4	CP4990-150	Fuse, 15 Amp Mini Automotive (Siren)
5	CP4990-250	Fuse, 25 Amp Mini Automotive (Lite)
6	CP4994	Label, front panel
7	CP4986	Panel, front
	CP4701	Relay, 40A SPST (light control)
8	CP4759-CV-06	Screw, 3/8" #6-32 black socket head (8 required)
9	CP4685	Switch, Momentary Push Button (Phaser and Horn)
10	CP4995-2	Switch, Red Rocker MOM - OFF - ON (Man - Standby - Auto)
11	CP4993	Switch, Red Rocker ON - OFF lighted (LT1 and LT2)
12	CP4748-2	Switch, Red Rocker ON - OFF - ON (Mech - Wail - Yelp)
13	CP4998	Transistor, output (replace in pairs, 2 required)
	Accessory	Description
	CP3571	Bracket, 'U' Dash Mount
14	CP4956-06	Connector, 6-pin Terminal Block Plug
	ED1608	Kit, Hardware (includes 1/4-20 bolts, nuts, and lockwashers for mounting amplifier)

SC-1012 PARTS

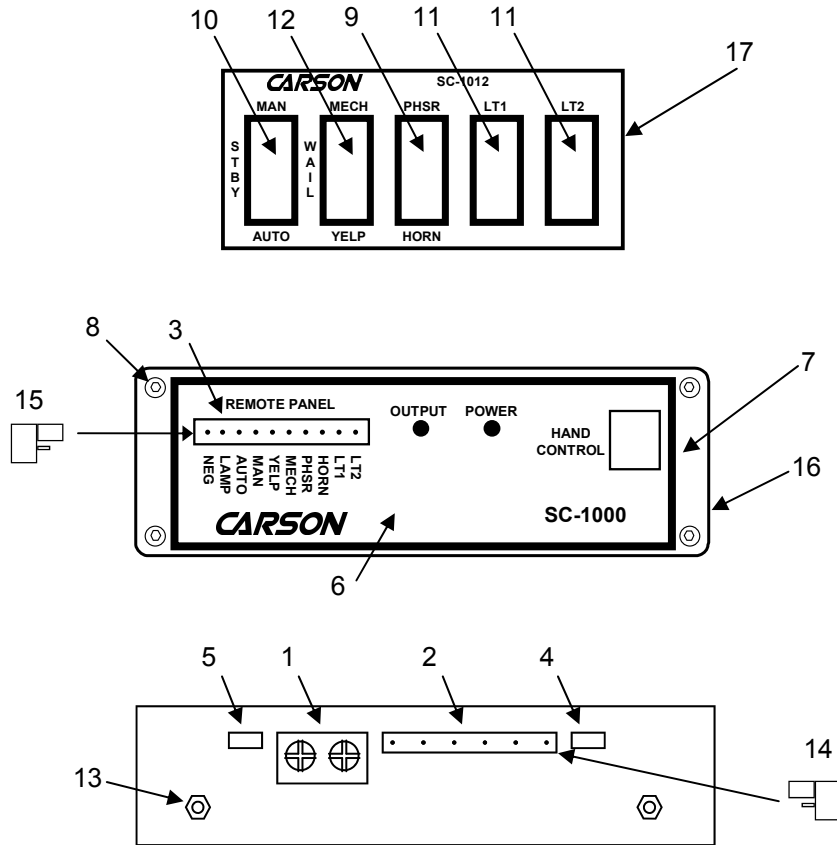

Item	Part #	Description
1	CP4989-02	Connector, 2-P terminal block
2	CP4957-06	Connector, 6-P header
3	CP4687-10	Connector, 10-P header
	CP4739	Cover, extruded (does not include Front Panel or slide out Chassis)
4	CP4990-150	Fuse, 15 Amp Mini Automotive (Siren)
5	CP4990-250	Fuse, 25 Amp Mini Automotive (Lite)
6	CP4996	Label, front panel
7	CP4987	Panel, front
	CP4701	Relay, 40A SPST (light control)
8	CP4759-CV-06	Screw, 3/8" #6-32 black socket head (8 required)
9	CP4751-2	Switch, Red Rocker MOM - OFF - MOM (Phaser - Horn)
10	CP4995-2	Switch, Red Rocker MOM - OFF - ON (Man - Standby - Auto)
11	CP4993	Switch, Red Rocker ON - OFF lighted (LT1 and LT2)
12	CP4748-2	Switch, Red Rocker ON - OFF - ON (Mech - Wail - Yelp)
13	CP4998	Transistor, output (replace in pairs, 2 required)
	Accessory	Description
	CP3571	Bracket, 'U' Dash Mount
14	CP4956-06	Connector, 6-pin Terminal Block Plug
15	CP4688-10	Connector, 10-pin Terminal Block Plug
	ED1608	Kit, Hardware (includes 1/4-20 bolts, nuts, and lockwashers for mounting amplifier)
	CP4062-K2523	Terminal, 3/16" insulated female Q.C. (for switches on remote panel, 15 required)
16	SC-1000-10 14	Remote Amplifier
17	SC-1012-10CH	Remote Panel Assembly (includes rocker switches)

SC-1022 PARTS

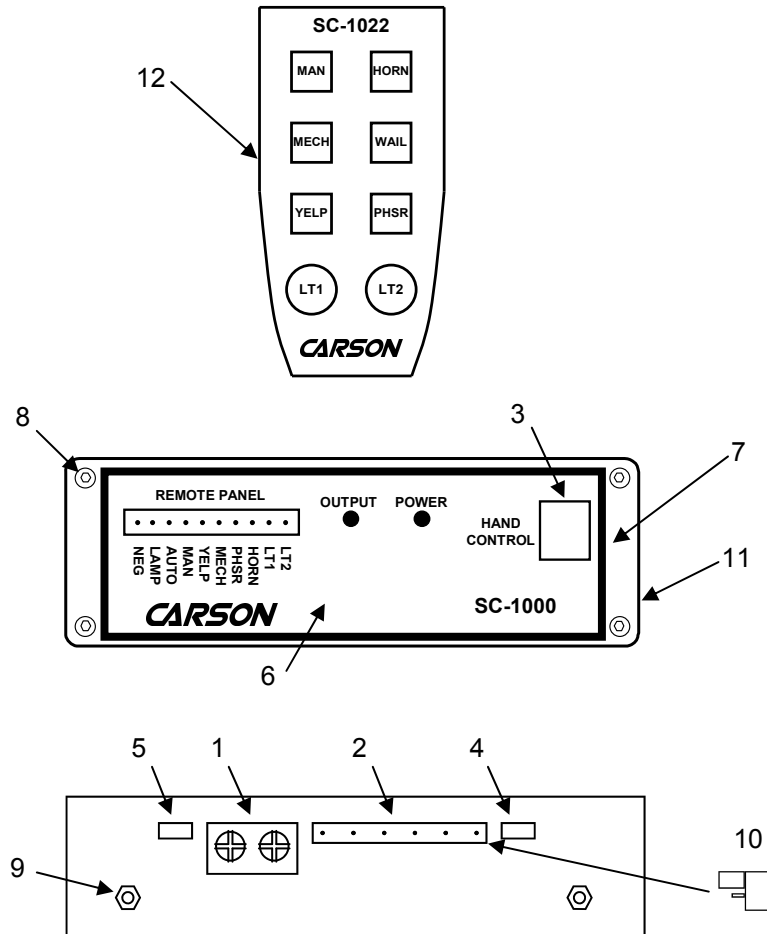

Item	Part #	Description
1	CP4989-02	Connector, 2-P terminal block
2	CP4957-06	Connector, 6-P header
3	520242-3	Connector, 6-P modular receptacle
	CP4739	Cover, extruded (does not include Front Panel or slide out Chassis)
4	CP4990-150	Fuse, 15 Amp Mini Automotive (Siren)
5	CP4990-250	Fuse, 25 Amp Mini Automotive (Lite)
6	CP4996	Label, front panel
7	CP4987	Panel, front
	CP4701	Relay, 40A SPST (light control)
8	CP4759-CV-06	Screw, 3/8" #6-32 black socket head (8 required)
9	CP4998	Transistor, output (replace in pairs, 2 required)
	Accessory	Description
	ED1865	Bracket, Kit, Hanger and Holder
	CP5003	Bracket, SC-1022 Hand Control Holster
	CP3571	Bracket, 'U' Dash Mount
	ED1753	Cable, Kit, 15FT Hand Control Extension
10	CP4956-06	Connector, 6-pin Terminal Block Plug
	ED1608	Kit, Hardware (includes 1/4-20 bolts, nuts, and lockwashers for mounting amplifier)
11	SC-1000-10 14	Remote Amplifier
12	SC-1022-10CH	Hand Control Assembly (includes cable)